

RADIO & MODEL ENGINEERING

*A Magazine of Technical Accuracy
for the Radio Engineer, Dealer, and Manufacturer*

Edited by M.B. SLEEPER

PORTABLE TUNED R.F. RECEIVER

THE HANDSOMEST PORTABLE SET YOU HAVE SEEN, USING FOUR UV-199 TUBES, AND FITTED WITH THE NEW PICKLE BOTTLE INDUCTANCES.

HARKNESS SET, FOR OPERATION WITH THE DIODE TUBE OR A CRYSTAL DETECTOR. A SPLENDID OUTFIT FOR PORTABLE WORK.

DETAILS OF THE GUNS AND FITTINGS ON THE SCALE MODEL OF A 310-FOOT U.S. NAVY DESTROYER.

20c a Copy—In England, 1/-

MARCH—APRIL—1924

Vol. 4

No. 3

"THE AIR IS FULL OF THINGS YOU SHOULDN'T MISS"



Why Big Cells Count in Radio "B" Batteries

THIS handsome metal case Eveready "B" Battery No. 766 costs only two-thirds more than the smallest Eveready "B" Battery, but it contains seven times the electricity! This makes the No. 766 over four times as economical as its baby brother. That is why most people buy it.

Its fifteen large cells give 22½ volts of strong, steady energy day after day. Cells that pour out power the moment you turn on your tubes. Cells that rest well when idle, renewing their vigor for your next demands.

No cells have a bluer-blooded ancestry than these. They are the product of thirty years of dry battery research and development of the world's foremost electro-chemical laboratories. We think that No. 766 is the handsomest battery



Eveready "B" Battery No. 766

22½ volts. Six Fahnestock Spring Clip Terminals, giving variable voltage from 16½ to 22½ volts, in 1½-volt steps. Length, 6¾ in.; width, 4¼ in.; height, 3¾ in. Weight, 5 lbs.

ever made. But that is a matter of opinion. It is a matter of engineering record, however, that this great standard "B" Battery has proved itself as perfect in performance as we are convinced it is superfine in appearance.

The 45-volt Eveready No. 767 contains the same large powerful cells as the No. 766. For maximum "B" Battery economy, therefore,

buy the 22½-volt Eveready No. 766 or the 45-volt Eveready No. 767, as you prefer. Here is the "B" Battery at its best.

NATIONAL CARBON COMPANY, Inc.
Headquarters for Radio Battery Information
New York San Francisco
Canadian National Carbon Company, Limited
Factory and Offices: Toronto, Ontario

If you have any radio battery problem, write to G. C. Furness, Manager, Radio Division, National Carbon Company, Inc., 130 Thompson Avenue, Long Island City, N. Y. Informative and money-saving booklets on "A," "B" and "C" Batteries sent free on request.



EVEREADY

Radio Batteries

-they last longer

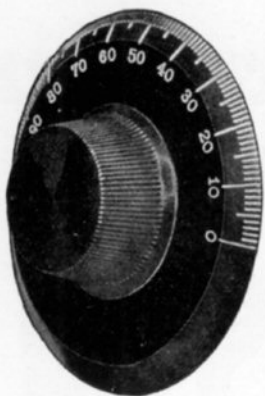

Dials—2", 3", 3¾, 4"
 Graduations, clock-wise
 or counter-clock-wise
 Holes, 3/16" or ¼" bush-
 ing
 Knobs, tapered or
 straight. All knobs are
 threaded into the dials

THE ONLY COMPLETE LINE *of Instrument* **KNOBS AND DIALS**

KURZ-KASCH knobs, dials, indicating knobs, and switch knobs comprise the only complete line so designed as to give a symmetrical appearance to all controls. Moreover, while all K-K products are molded of genuine Bakelite, the prices of these parts are so reasonable that they are no more expensive than cheap, dull knobs and dials molded from "mud." If your dealer doesn't carry the K-K line, write us, giving his name.

MANUFACTURERS

Knobs and dials of genuine Bakelite aren't expensive if you get them from Kurz-Kasch. Our line is so complete that we can supply whatever your instruments require. On molded parts of any description our factory, the most complete molding plant in the country, can give you quality, speed, and prices which will surprise you. Send us your blue prints.

KURZ-KASCH CO. SOUTH BROADWAY
 DAYTON, OHIO

WIRELESS



APPARATUS



No. 727 Bestone multiple phone plug connects one, two or three phones in series by simply pressing the buttons.

AT QUALITY
 DEALERS—\$1

Results cannot be obtained from the most carefully constructed receiver, should any one part be other than perfect. Time, labor and money are often wasted on inferior accessories. Bestone apparatus is designed and built for maximum efficiency.

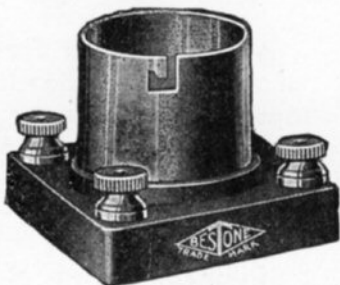

No. 724 V. T. socket with special designed interlocking positive contacts. Nickel plated shell and red bakelite base.

AT QUALITY
 DEALERS—\$.75

HENRY HYMAN & CO., Inc.

MANUFACTURERS

476 Broadway
 New York

212 W. Austin Ave.
 Chicago

Dubilier Duratran

reduced from \$5⁰⁰ to

INCREASED production facilities have lowered the manufacturing costs of the Dubilier Duratran Radio-Frequency Transformer.

And the public receives the benefit in a big price reduction.

**No missing wavelengths with
the Duratran**

Think what this means.

The Dubilier Duratran is designed to bring in all the broadcasting stations—not just one or two. And it does this with an amplification factor of over twenty for all broadcasting wavelengths.

Every Duratran is carefully tested for stability, amplification and wavelength range before it leaves the factory.

Ask your dealer for *free* blueprints of Duratran radio-frequency hook-ups. If he has none write to us for them and give us his name.

**DUBILIER CONDENSER AND RADIO
CORPORATION**

42-46 West Fourth Street - New York

DUBILIER DEVICES



\$4



PORTABLE TUNED R. F. RECEIVER

Operating on UV199 tubes, this set can be run from dry cells or an automobile storage battery, giving loud speaker volume on local stations, and an unlimited range with telephones

THE UV199 or C299 tubes have made real sets really portable, not only by decreasing the size of the equipment but by doing away with the necessity for using a storage battery to supply the filament current. In the type 5800 portable set we have tried to meet all requirements for those who want a good set to use on the motor boat, the automobile, or on hiking trips.

If the batteries are not included in the cabinet which takes the set, the outfit can be put up in a small case, as the panel measures 7 by 14 ins., with a depth required of 7 ins. behind the panel. Four 6-in. Eveready dry cells or two 7211 two-cell units connected in parallel will supply the filaments. Operated from an automobile storage battery, a cable can be run from the dash light socket to a plug in the E X T. BAT. jack. You will notice that 50-ohm rheostats are specified to allow the use of 6 volts on the tubes. In addition, two 45-volt batteries, type 767, are needed and a C battery type 771.

The
Type 5800
Receiver

As for the apparatus itself, it is a modification of the very successful type 5300, changed over to accommodate the dry cell tubes, and equipped

with the new "pickle bottle inductances" for the fikits, which give extremely high efficiency, and require only a small amount of space. A special section is devoted to these coils, for they are made in an entirely new way which will become very popular as soon as Experimenters recognize their efficiency and learn how to make them.

The circuit consists of a fikit for the antenna coupling, and another for the R.F. transformer, both being tuned with 0.0005 mfd. condensers. In addition, there are two steps of A.F. transformers. A special advantage of the fikit, with its untuned primary, is that almost anything can be used for an antenna. This set does not oscillate at any setting. Consequently the speech or music is as clear as with a crystal detector. At Darien, Connecticut, we brought in Pittsburgh, Schenectady, Chicago, and Atlanta with excellent volume, using the regular testing antenna, a 60-ft. wire 20 ft. high at each end.

Standard
Parts
Required

Portable equipment must be built up on Bakelite panels, either Formica, Dilecto, or Condensite, for hard rubber does not stand up under hard

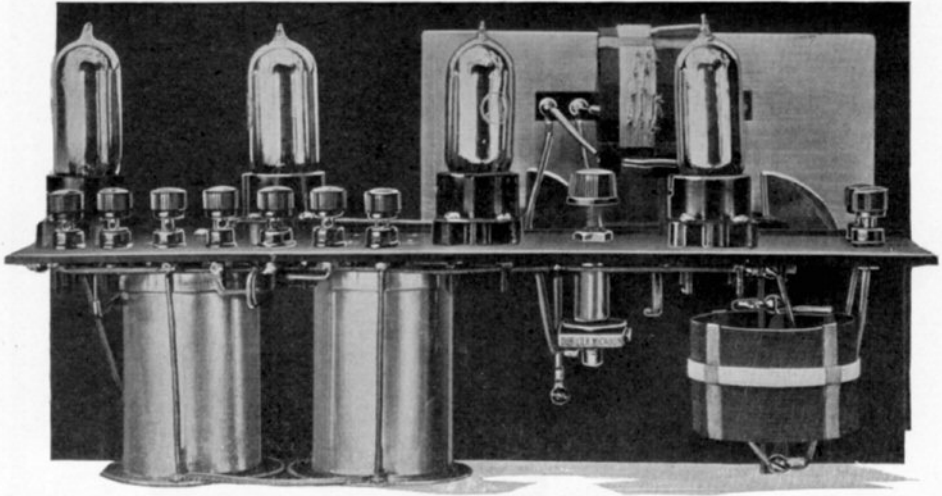

Fig. 1. Showing the arrangement of the transformers and the fikit which provides coupling to the antenna and ground. Notice that the transformers rest on the inside of the cabinet.

use. The 0.0005 mfd. condensers are of the Comsco design, very well made and most reasonable in price, the rheostats from Amsco, with Kurz-Kasch Bakelite dials 3 ins. in diameter for the condensers, and 2 ins. for the rheostats. Two Carter jacks are needed with Pacont plugs. For two pairs of phones, a Duo-jack should be used, into which two pairs of phones or one pair of phones and a loud speaker can be plugged. The aluminum shield, of No. 20 gauge, prevents all capacity effects.

At the rear are the four General Radio sockets, Ark transformers, Electrad Vari-ohm carrying a Micadon, and the fikit. Eby binding posts provide connections to the leads. If you want any type of special cabinet made up for this set it can be obtained from the Radio Cabinet Company, 470 Bergen St., Brooklyn, New York.

Three panels are needed for this set, one 7 by 14 by $\frac{3}{16}$ in., and two $3\frac{1}{2}$ by 13 by $\frac{3}{16}$ in., in addition to the four coil mounting strips, two of which are $3\frac{1}{2}$ by $\frac{1}{2}$ by $\frac{3}{16}$ in, and two $3\frac{1}{4}$ by $\frac{1}{2}$ by $\frac{3}{16}$ in. These latter pieces can be cut from panels $22\frac{1}{2}$ by $3\frac{1}{2}$ by $\frac{3}{16}$ in.

Fig. 4 shows the front panel and shield at one-half size and Fig. 6 the rear panels and coil mounting panels. All holes are to be made with a No. 18 drill with the exception of the shaft holes and jack holes which are marked $15/32$ -in. Concentric circles call for countersinking for flat head screws. Dimensions can be scaled off in the usual way, measuring from the outside of

the lines which outline the panels to the cross marks at the centers of the holes. All distances on the drawings should be doubled when they are transferred to the panels. If you prefer, you can get the full size blue prints and, putting them directly on the panels, mark through with a center punch.

The mounting strips should be drilled before the slots which allow for the primary windings, are made. To cut the slots, saw into the strip for $1/16$ in. at each end. Then, with a chisel or even a center punch, chip out the bakelite. You must be very careful in doing this work for thin, narrow strips of bakelite are liable to crack.

The aluminum shield is of No. 20 gauge, measuring 6 ins. high by $7\frac{1}{2}$ ins. long. The outline of it is shown in Fig. 4. It should be drilled with the same holes as the panel.

Winding the Pickle Bottle Coils

You will find it very interesting and very easy to wind the pickle bottle coils for the two fikits. This new type of

coil is the most efficient that can be made, as it needs no shellac or varnish, and has no dielectric material in the field other than the mounting strips. Therefore, no losses are introduced. While this type of coil is self-supporting, you will be surprised to see how very strong it is.

As a former for the coil, get a pickle or preserve bottle, $2\frac{1}{4}$ ins. in diameter, which has from eight to fourteen sides; the exact number is not important, for the flats are merely to accommodate the mounting strips. Cut up four strips of gummed paper, such

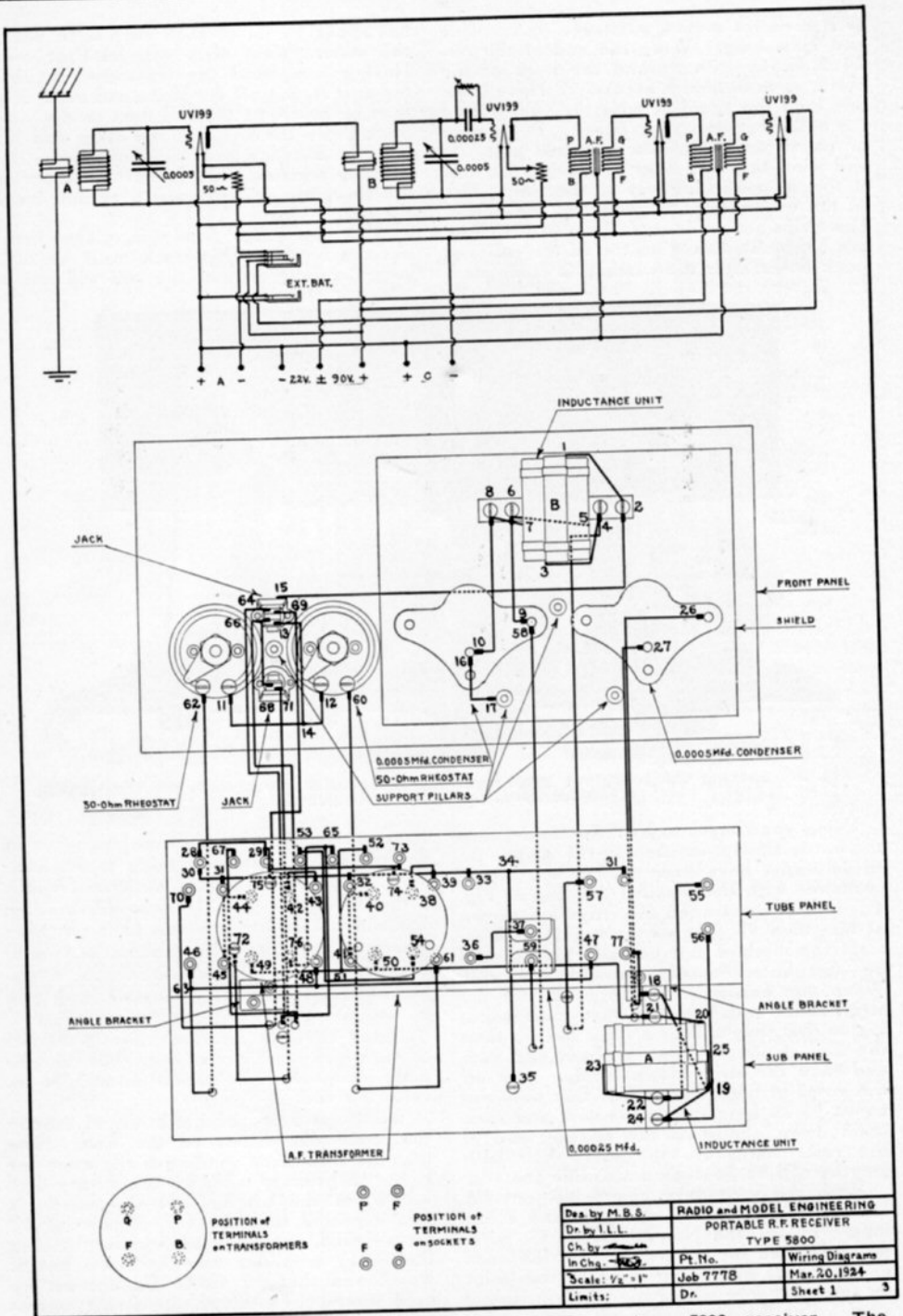

Fig. 2. Schematic and picture wiring diagrams of the type 5800 receiver. The schematic diagram shows the general arrangement of the circuit, and the picture diagram, the actual layout of the wiring. The tube panel is turned up so that you see the underside.

as is used for sealing packages, $\frac{1}{4}$ in. wide and 7 ins. long. Wrap the end of the No. 24 S. S. C. wire around the neck of the bottle so as to hold it securely. Have some one hold the spool of wire for you. Hold the bottle between your knees. Put a strip of paper on the bottle, gummed side up, and wind the wire over it, leaving $1\frac{1}{2}$ ins. of the strip sticking out at the side. Put on the other strips as you turn the bottle. The strips are made extra long so that they can be doubled over on top of the coil and stuck down after the winding is completed.

Let about $\frac{1}{2}$ in. of each strip stick out at the start. This, also, will be bent over. Having completed the six turns, required for unit A, cut off the strips and bend them over as before at the end next to the start. Stick down the strips at the other end just for the distance that they pass over the primary winding, but do not cut them off for the they, too, will be run over and inside the coil.

With the strips firmly in place, break out the bottle. This work must be done very carefully so that the coil will not be

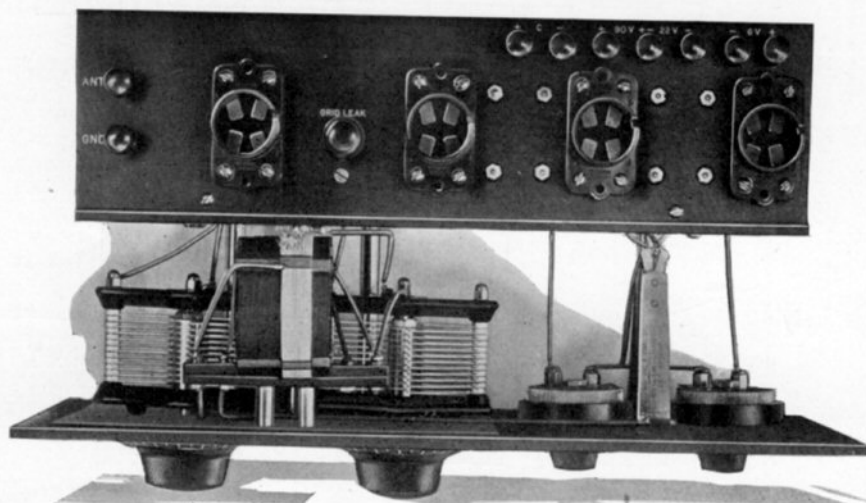

Fig. 3. Spacing the tube unit back from the front panel gives room for the variable condensers, jacks, and rheostats.

Using your knees to hold the bottle, turn the bottle slowly, moistening the strips, until 70 turns have been wound on, in accordance with the detailed drawing in Fig. 4. In that illustration the strips are shown at less than 90 degrees apart just to illustrate the method, but actually they should be distributed evenly around the coil. When you finish the 70 turns, cut off the strips at the ends near the start of the winding so that they will be a little shorter than the coil is long. Then moisten the gum and stick the strips down firmly. Cut off the strips at the other end so that they are about $\frac{1}{2}$ in. longer than the coil, and stick them down almost to the starting end of the coil. Later on, the extra half inch lengths will be bent around inside the coil.

With the secondary completed, cut off four gummed strips $\frac{1}{4}$ in. wide and 3 ins. long. Fasten the No. 20 D. C. C. wire, which is used for the primary, at the neck of the bottle and bring it up to the point on the secondary where the winding should start. Put the four strips of paper under the wire, directly over the other strips.

bent out of shape or the insulation cut by the glass. It is an easy thing to do, however, so that you should have no trouble. As soon as the glass is removed, moisten the ends of the strips which have not been struck down, bring them over to the edge of the coil, and bend them inside for a distance of half an inch. That will give you a very substantial self-supporting coil.

Leads about 6 ins. long should be left at each end of the secondary, but the primary leads should be cut off about $\frac{3}{16}$ in. from the coil.

Wind unit B on another bottle of exactly the same dimensions as the first. Note that the secondary winding is the same for B, but the primary takes 12 turns instead of 6. When the original set was made, it was expected that the full number of 12 turns could not be used without making the R. F. amplifier tube oscillate, but it was found that 12 turns did not set up oscillations. Therefore, it is not necessary to make taps on the primary winding as was done on the outfit.

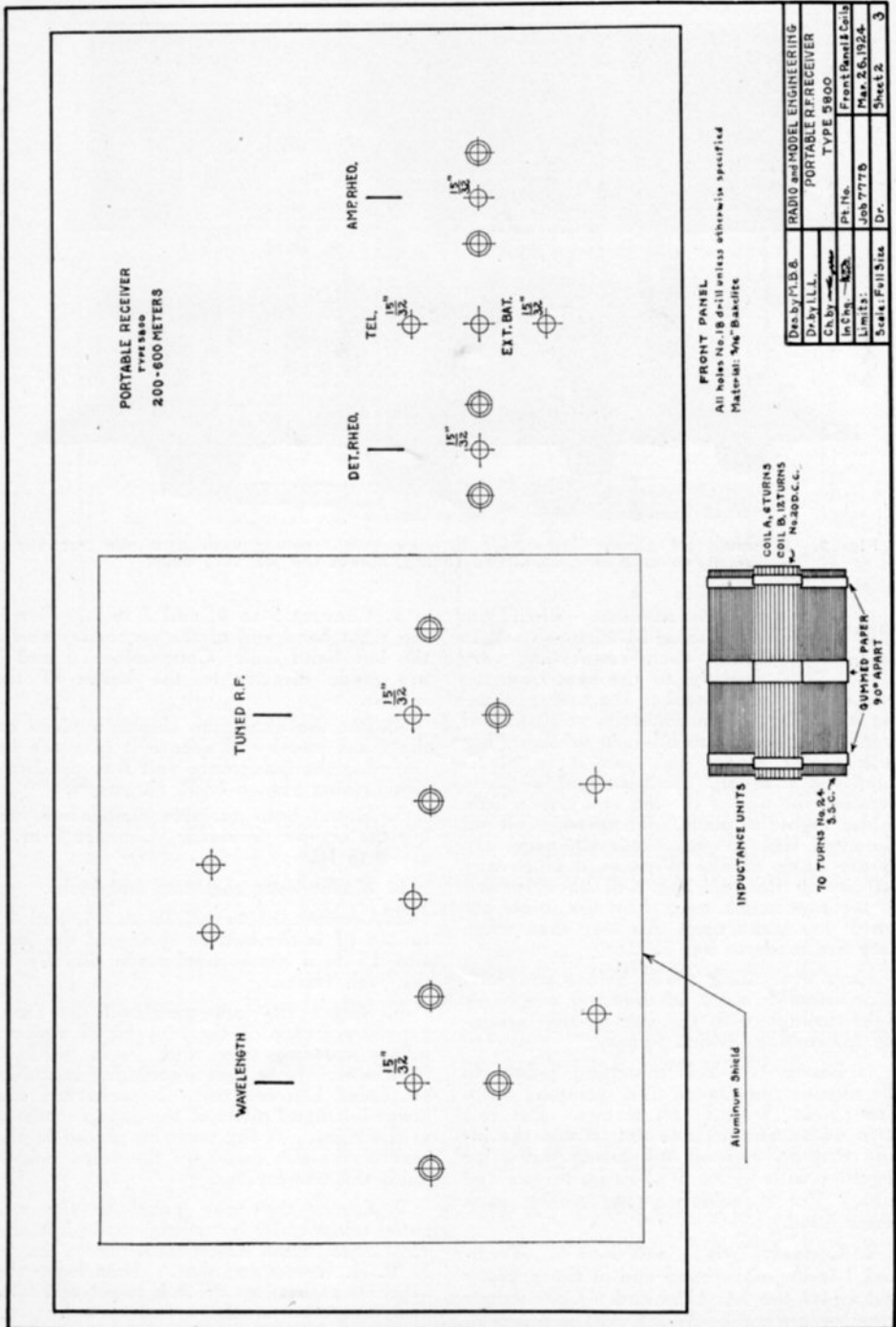

Fig. 4. One-half size drawing of the front panel and the pickle bottle coils. Note that the outline of the aluminum shield is also given.

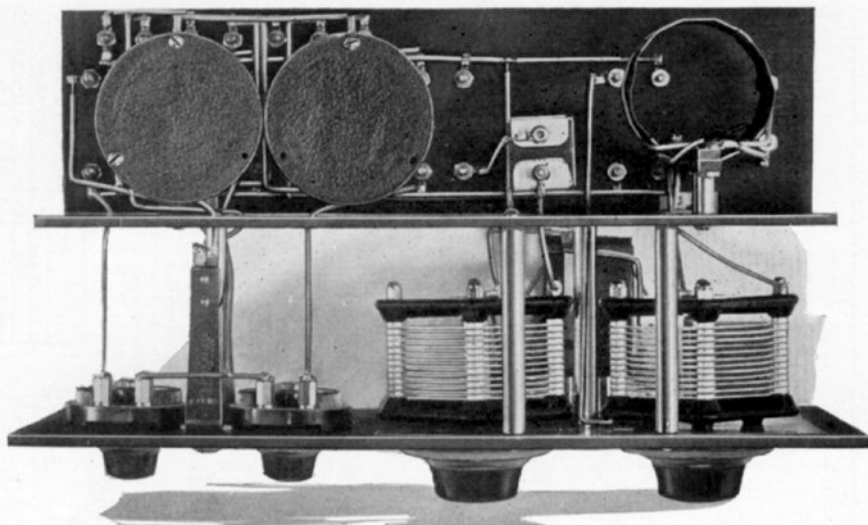

Fig. 5. It would be almost impossible to wire this receiver with bus bar but the Wiritt, covered with varnished tubing, makes the job very easy.

Assembly and Wiring

It is necessary when you use tubing in wiring a set, to make each connection very quickly, or the heat from the iron will be transmitted to the tubing, causing it to char. Consequently, you will find it most convenient to fill each soldering lug with solder before you put it in place. Simply put a very small amount of paste between the lips of the lug and melt a little solder right in place. Then wipe off all the paste from the lug. It is not necessary to use paste on the Wiritt as it is already sufficiently tinned. You will be surprised to see how much more firm the joints are when you make them this way than when they are made to bus bar.

Have everything ready before you start your assembly work so that you can carry right through with the step-by-step assembly instructions which follow.

1. Fasten two coil mounting pillars to the outside inductance unit clamping strip. Use $\frac{1}{2}$ in. 6-32 F. H. screws. Put this strip outside inductance unit B and the inside strip in the coil and fasten the strips together with $\frac{1}{2}$ in. 6-32 R. H. screws and nuts. Put a soldering lug under each screw head.

2. Connect 1 to 2, and 3 to 4. Terminal 1 is the right hand end of the primary coil and 3 the left hand end. Connections 2 and 4 are made directly to the heads of the screws.

3. Connect 5 to 6, and 7 to 8. Five is the right hand end of the secondary and 7 the left hand end. Connections 6 and 8 are made directly to the heads of the screws.

4. Put the aluminum shield in place on the front panel and secure it in place by fastening the inductance unit B to the front panel, using $\frac{1}{8}$ in. 6-32 R. H. screws.

5. Mount both variable condensers, using the screws provided. Connect 6 to 9, and 8 to 10.

6. Mount both rheostats and jacks.

7. Connect 11 to 12, 13 to 14, and 15 to 2. 13 is the bottom spring of the jack and 15 is a connection made directly to the jack frame.

8. Mount the sub panel on the front panel by means of the four panel support pillars fastening them with $\frac{1}{2}$ in. 6-32 R. H. screws. Note that a soldering lug must be placed between the sub panel and the lower left hand pillar of the group of three at the right. A lug must be placed at the rear of the sub panel on the screw which holds this same pillar.

9. Fasten the tube panel to the sub panel temporarily by means of the left and right hand angle brackets, using $\frac{1}{2}$ in. 6-32 R. H. screws and nuts. Then leave the brackets secured to the sub panel and take away the tube panel.

10. Connect 16 to 17.

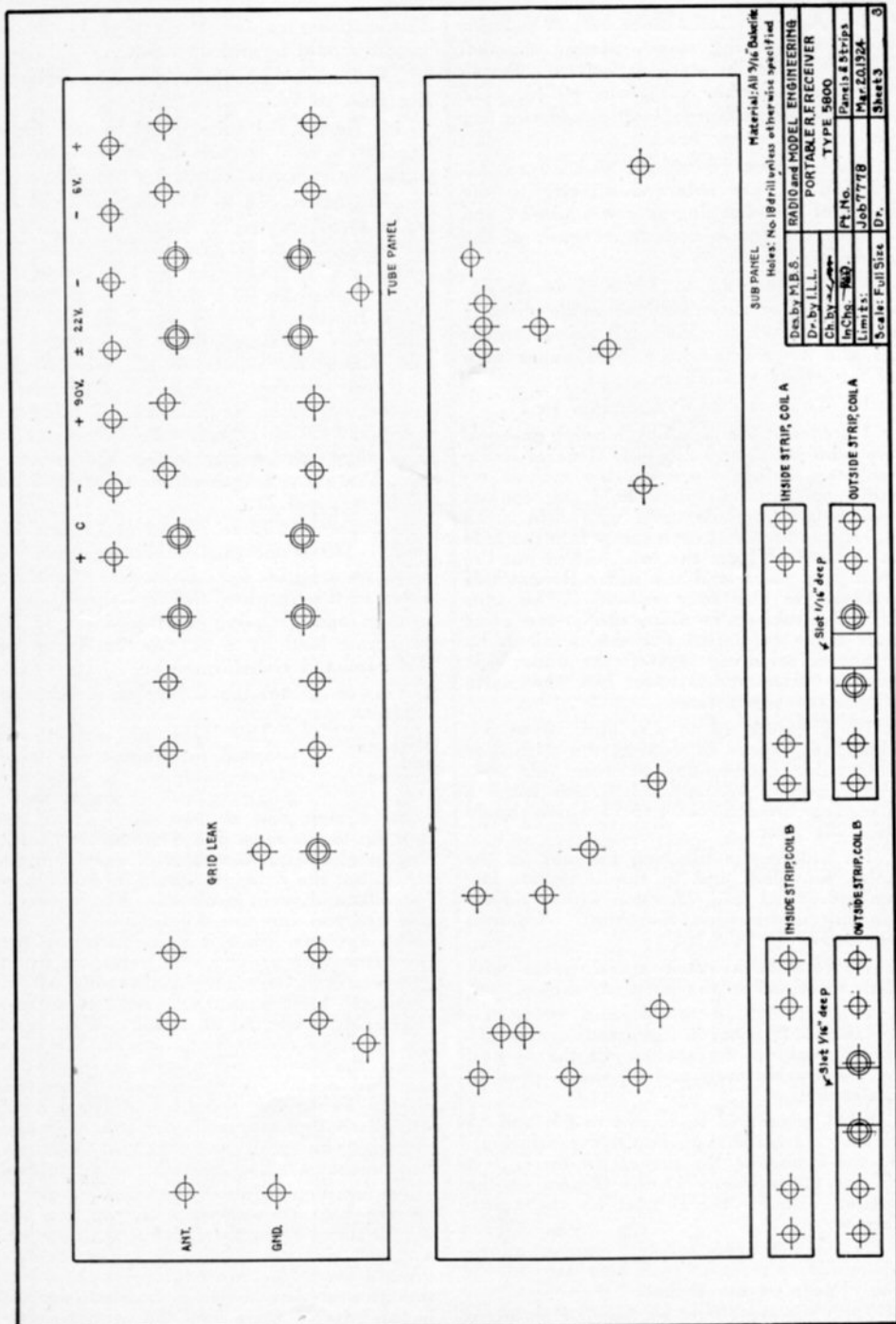

Fig. 6. One-half scale drawing of the tube and sub panels and the strips for mounting the fittings.

Material: All $\frac{3}{16}$ Duraline
 Holes: No. 18 drill unless otherwise specified

Des. by: H. B. S.	RADIO and MODEL ENGINEERING	Panel: 8 Strips
Dr. by: I. L. L.	PORTABLE R. F. RECEIVER	Job: 777B
Ch. by: J. J. J.	TYPE 9600	Mar. 20, 1924
Lim. Ex:		Sheet 3
Scale: Full Size		

11. Assemble inductance unit A between the two clamping strips, putting the coil support pillars in place as before. Fasten the strips together with four $\frac{1}{2}$ in. 6-32 R. H. screws and nuts, with a soldering lug under each screw head.

12. Connect 18 to 19, and 20 to 21. 18 and 21 are soldered directly to the heads of the clamping screws while 19 and 20 are the lower and upper ends of the secondary winding.

13. Connect 22 to 23, and 24 to 25. 22 and 24 are connections made directly to the heads of the lower clamping screws; 23 and 25 are the lower and upper ends of the primary winding.

14. Connect 26 to 18, and 27 to 21.

15. Mount the nine Eby binding posts on the tube panel and the four General Radio sockets. Before mounting the sockets remove the screws which hold the contact springs and replace them with 1 in. 6-32 R. H. screws. Put each screw into the hole in the socket from the top. Then put the spring in place and the nut. Repeat this process on the four sockets. The nuts hold the sockets in place and at the same time make connections to the terminals by means of soldering lugs on the under side of the tube panel. Cut off the extra lengths of the screws.

16. Connect 28 to 29, and 30 to 31. Make allowances in cutting the varnished tubing for connections between this wire and lugs 31, 32, and 33. Also leave a place for connections 34 to 35 which should be made next.

17. Mount the Electrad grid/leak in the holes provided, and to the terminals fasten a 0.00025 mfd. Micadon with a soldering lug under each thumbnut. Connect 36 to 37.

18. Mount the Ark transformers with their terminals in the positions shown.

19. Connect 38 to 39, and 40 to 41. 38 is the P post on the transformer, 39 the P post on the socket, 40 the G post on the transformer, and 41 the G post on the socket.

20. Connect 42 to 43, 44 to 45, and 65 to 76. 42 is the P post on the transformer, 43 the P post on the socket, 44 the G post on the transformer, 45 the G post on the socket, and 76 the B post on the transformer.

21. Connect 46 to 47, making allowances for connection from this wire to 48, the F post on the socket.

22. Connect 49 to 50, leaving an extra length of 10 ins. of wire to be secured later to lug 21 on the A inductance unit.

Make allowance for connection 51 to 52 which should be put on next.

23. Connect 53, the minus 22-volt binding post, to 54.

24. Fasten the tube panel to the angle brackets which are already in position, using $\frac{1}{2}$ in. 6-32 R. H. screws and nuts.

25. Connect 22 to 55, 18 to 77, 24 to 56, 4 to 57, 58 to 59, 60 to 61, 62 to 63, 64 to 65, 66 to 67, 66 to 68, 69 to 70, and 71 to 72. 64 is the top contact on the jack, 65 the plus 90 V. binding post, 66 the third contact down on the jack, 67 the minus 6 V. binding post, 68 the upper contact on the lower jack, 69 the second contact down on the upper jack, 71 the lower contact on the lower jack, and 72 a lug on a $\frac{1}{2}$ in. 6-32 R. H. screw held by a nut to the flange on the transformer. Also connect the extra length of wire from 49 to 50 to terminal 21.

26. Connect 73 to 74, 74 to 75, and 75 to 29. 73 is the plus C binding post, 74 a lug on a $\frac{1}{2}$ in. 6-32 R. H. screw held by a nut to the flange of the right hand transformer, and 75 a lug on a $\frac{1}{2}$ in. 6-32 R. H. screw held by a nut to the flange of the left hand transformer.

This completes the wiring of the receiving set.

Antenna and Ground This type of receiver is adapted for almost any kind of an antenna. If you are going to use it on a small boat, stretch one or two wires from the bow up to the mast and down to the stern. The height is not a matter of great importance, but the antenna should be as long as possible and well insulated. For automobile use you can use the frame of the car as an antenna, since it is insulated by the tires from the ground. A better antenna, however, can be made by throwing 50 ft. of No. 18 annunciator wire up into a tree. It should be carried in a coil. When you are ready to throw it up, stretch the wire along the road, and attach a weight to the end which is to go into the tree. Simply swing the weight and let go. It will catch somewhere in the branches and provide you with an excellent antenna. Wire fences are also good for this purpose.

As for a ground, an automobile acts as an excellent counterpoise, if you use the wire in the tree or the fence as an antenna. You can also use a fence as a counterpoise ground or, if you are near a brook, solder the ground wire to a tin can and drop it in the water. On a boat the copper sheathing on the bottom, or the engine gives an excellent connection.

RADIO & MODEL ENGINEERING

Publication Office

Lyon Block, Albany, N. Y.

Editorial and General Offices

A-52 Vanderbilt Ave., N. Y. C.

Twenty cents per copy in the United States and Canada; in foreign countries one shilling. Two dollars per year, twelve numbers in the United States and Canada; ten shillings in foreign countries.

Application for entry as second class at Albany, N. Y. pending.

Vol. IV MARCH-APRIL 1924 No. 3

EDITORIAL

IF radio manufacturing were in the same class as suits, shoes, or hats, we would speak of the changes in designs as new styles. Built on a foundation of technical development, styles are indicated as new types or systems.

Style or type, we all want equipment to change as long as those changes are along the line of advance either in mechanical or electrical features. There are, of course, passing fads created largely by gyp houses to stimulate business periodically. These are generally promoted by newspapers, but have no place in R and M.

In this issue, however, you will find a showing of "spring samples" which set precedents to be widely followed, and which will last not for weeks but for many months. More important is the pickle bottle coil. This name, tho not elegant, is accurately descriptive, for the reason that the first models were actually wound on pickle bottles, tho for production the bottle would be replaced by a simple collapsible mandrel.

These coils will be widely used because they are fundamentally right. Contrary to popular opinion, the idea of the spider web coil, or the open weave coils wound on pins is wrong, wrong for the simple reason that, for the same inductance, they have a much greater high frequency resistance than the usual single-layer coil on a tube. In fact, the only coil more efficient than one wound on a tube is one wound on a tube with the tube afterward removed.

That is the pickle bottle coil — the most efficient type of winding in its most efficient form. If you need confirmation of this

statement, notice the inductances shown in photographs taken in the Bureau of Standards' laboratories, — always single-layer coils supported not on solid tubes but open frames. The pickle bottle coils have less insulating material in the field than any other type. That's the reason why this new style or method is going to be widely used, not for a matter of weeks while the idea is new, but for a long time to come.

Another feature introduced this month is an improved system of wiring. The method now standard, using square tinned copper bus bar, also originated in the R and M laboratory, is good, so good that it has steadily held its own against innovations such as round bus bar or gold plated wire. It has, however, very definite limitations. When properly carried out, bus bar wiring is unquestionably handsome in appearance, but, judging from the appearance of the average home-made set, few Experimenters can or do use it as it is intended. Poor bus bar wiring looks very crude indeed. Manufacturers have had their troubles with it, too. But bar is so much stronger than soldered joints or soldering lugs that, when any strain is put on the set in handling or in transportation, the bus bar holds and the joints or lugs give way, where, with wire a little more flexible, the strain would be taken up by a movement of the wire itself, thus reliving the connections.

The new conductor which will be employed from now on is of No. 18 B. & S. gauge round tinned copper, of special temper. When I went out shopping for this wire, I found that plenty of soft drawn copper wire was obtainable, but the soft temper made the wire too flexible, and the natural oxidation made soldering too difficult. Therefore, I went to Mr. Goldmark, of the James Goldmark Company, New York City, the man who drew the first tinned bus bar, and told him my story. He worked with me to produce the No. 18 tinned wire of the correct temper suitable for wiring. This is put up on one-half pound spools, containing 100 feet. It is a simple matter to stretch the wire yourself, and cut it up in handy lengths. This is, of course, much cheaper than bus bar.

Then I went to Mitchell-Rand for varnished tubing of special small size to fit the wire exactly. Mr. Stevens helped me there. The result was a neat, flexible tube just right for the wire, giving, as you will see from the illustrations in this issue, a very trim appearance.

M. B. SLEEPER, Editor.

Commercial Type Sets and Circuits

The Harkness Receiver

A non-oscillating circuit using tuned radio frequency amplification and reflex connections with a crystal or Diode detector.

ONE of the most convenient 2-control single tube sets is the Harkness type. The set itself is illustrated below and, on the opposite page, are diagrams showing the connections with a crystal or Diode detector.

Essentially the circuit is made up of fikit coupling the antenna to the grid circuit of the tube. The primary is untuned and the

The fikit connected in the antenna circuit is wound on a bakelite tube 2 ins. long and $2\frac{1}{2}$ ins. in diameter. The secondary coil, which is wound on first, consists of 60 turns of No. 28 wire covered with an inside wrapping of cotton and an outside wrapping of silk. A layer of paper is then put over the secondary and 15 turns wound on for the primary. The fikit

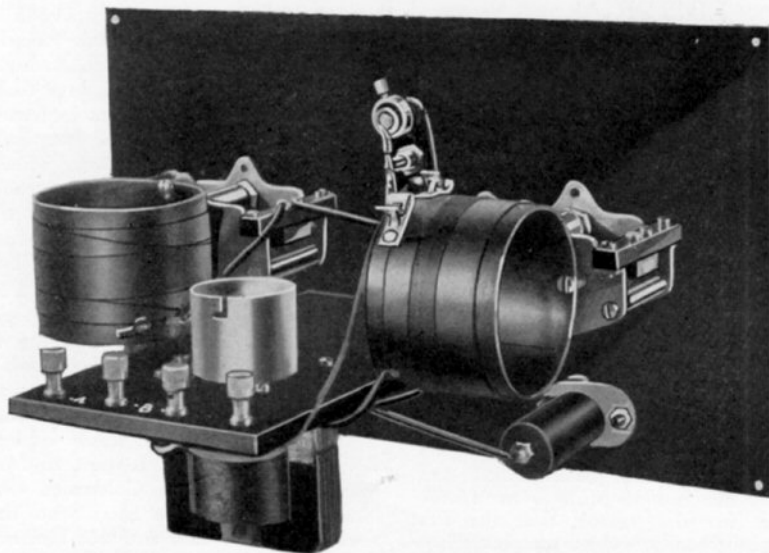

A plain and simple arrangement of the controls gives the Harkness set an attractive appearance, and reduces the length of the connecting wires

secondary, controlled by a 0.0005 mfd. condenser is designed to cover the broadcast wavelengths. A similar arrangement is employed between the plate circuit of the tube and the crystal detector or Diode which has in circuit also the primary of an audio frequency amplifying transformer. The secondary is connected in the filament side of the grid circuit. This arrangement, using the tuned radio frequency transformer, gives very sharp tuning and provides adjustment for maximum efficiency at all frequencies within the wavelengths range of the set.

which serves as a tuned R. F. transformer has 60 turns of the same wire for the secondary and 35 turns for the primary, wound also on a tube 2 ins. long by $2\frac{1}{2}$ ins. in diameter. If particularly sharp tuning is required a tap should be taken off at the center of the secondary for connection to the primary of the audio transformer instead of connecting it at the end of the coil as the diagram shows.

In the accompanying illustration these coils are mounted on Hammerlund condensers altho the Sherman condensers can be used if you want a less expensive type.

The balance of the equipment comprises a Fil-ko-stat for the filament control, a General Radio audio frequency transformer, a crystal detector, and Bestone socket, mounted underneath the panel with the socket tube going up through a $1\frac{1}{2}$ in. hole.

A somewhat simpler type of adjustable crystal detector is the Rusonite. For a fixed crystal the new Rasla detector is recommended.

If the Diode tube is substituted for a cry-

Amperites instead of rheostats. This is a very practical arrangement as neither the UV201-A or UV199 is critical, as to filament current, when used as an amplifier. The Amperite allows the use of four dry cells on a 201-A or three dry cells on a 199. Operating the former on Eveready 7111 dry cells, the dependable life of the cells is 125 to 150 hours or, on the latter, approximately 500 hours, assuming that the set is in operation for 2 to 4 hours every day. It is interesting to note that the cost of operating the 201-A, on that

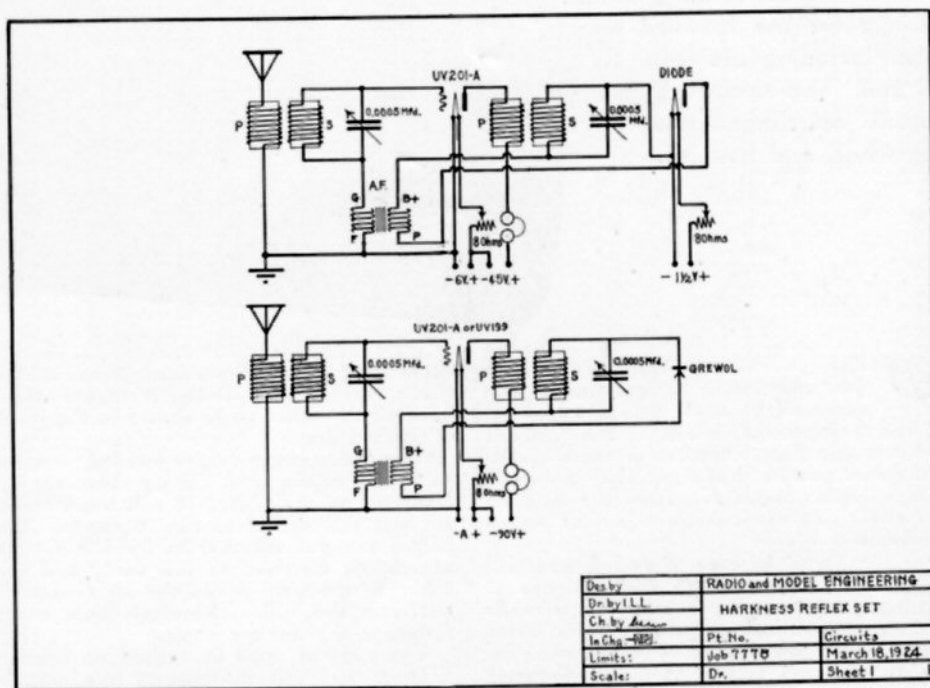

Above, the connections as they are made when the Diode is used as a detector. Below, the circuit for a crystal

stal, the socket can be mounted directly in front of the UV201-A socket.

This outfit, operating on a small antenna, brings in the local stations with splendid volume and experimenters fortunately situated have been able to hear on the loud speaker stations several hundred miles away. For a portable set this is an excellent type as the untuned primary allows it to be used on almost any kind of an antenna. A UV199 tube can be substituted for the 201A if it is necessary to reduce the filament current consumption.

A similar type of circuit, using an audion detector was described in Reflex and Radio Frequency.*

Some Harkness sets are equipped with

basis, is one cent per hour, or less than a third of a cent per hour for the 199.

By changing the mechanical design of this set, and reducing the space occupied by the condensers, by substituting Connecticut Triple Range condensers, the outfit can be reduced almost to pocket size. Then an Eveready 3 should be used for the A battery and a small $22\frac{1}{2}$ -volt battery for the plate voltage, a UV199 tube operates for about 25 hours on this tiny filament battery, or even longer if the set is not used very long at a time and the current consumption cut down to minimum.

* Reflex and Radio Frequency, published by M. B. Sleeper, Inc., New York City. Price 50c.

Construction of a One-Eighth Inch Scale Model 310-Foot U.S. Destroyer

Part 2. Details of the part and fittings for the forward section, including the 4-in. R. F. gun, anti-aircraft gun, binacle, searchlight, steering wheel and hatches

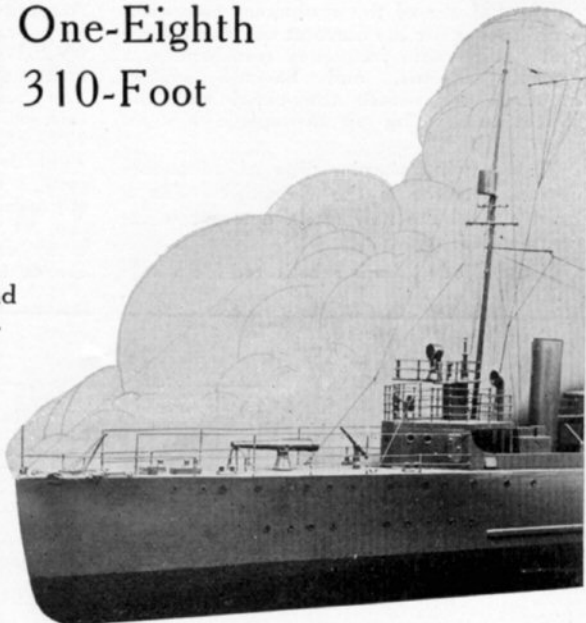

WHILE you are working on the hull, you may want to get under way some of the small fittings, too. Figs. 4 and 5 show the details of the forward section, and Fig. 6 illustrates some of the individual parts at full size. They are most interesting to make, for, from the simplest materials you can construct perfect reproductions.

Forward Deck Fittings.

In Figs. 4 and 5 you will see flagstaff and bullnose at the very bow. This is made up of a triangle of thin brass sheet, $\frac{1}{4}$ -in. on a side, to which a $\frac{1}{8}$ -in. length of brass tubing $\frac{1}{8}$ -in. in diameter is soldered. In this ring a hole is drilled to take the mast stay, and another in which the flagstaff, a 1-in. length of No. 24 gauge brass wire, is soldered. A tiny bit of solder at the top serves for the ball. The complete part should be painted a battleship grey. This color, ground in japan, can be purchased in a tube. It is only necessary to thin it with turpentine.

Aft of the flagstaff is the anchor davit. You can take off the actual dimensions from Fig. 6. This has a base of brass sheet $\frac{1}{32}$ -in. thick, to which are soldered three brass wires, one of No. 20 brass wire and two of No. 24. The hole at the center of the base is to fasten it to the deck. This, too, must be painted grey.

The oval-shaped hatch to the lamp locker is just a little piece of $\frac{1}{4}$ -in. wooden

dowel, cut flat on two sides. It has a hole for a tiny brad to fasten it to the deck. Like all the other parts shown in Fig. 6, it is painted grey.

Two deck stoppers are needed, one on each side of the bow. These are made up from two pieces of No. 30 soft brass sheet, cut out and drilled as Fig. 6 shows. The halves are put together to form a Y, one arm being fastened to the deck, and the other to the side, while the stem extends out from the hull. The single hole is for fastening the anchor chain.

The capstan must be turned up from a $\frac{5}{16}$ -in. rod. At the bottom is a mounting pin. With this go the roller bits. The base is cut from No. 20 brass sheet, as shown. In the two left hand holes go the two rollers, one of which is illustrated.

Four of the 4-in. R. F. guns are needed. The barrel and base can be turned from wood, with the supporting bracket cut from No. 30 brass sheet. Because of the method used to mount the anti-aircraft gun, two of which must be made, it is advisable to turn the standard from brass, split and bent out at the top to take the barrel.

Safety rails are set up forward of the R. F. guns. The rail is made of No. 24 gauge brass wire, carefully bent as shown. You will see that extra lengths are left so that the rail can be mounted on the deck. When you have formed the long rail, mount it on a block of wood. Put the vertical sup-

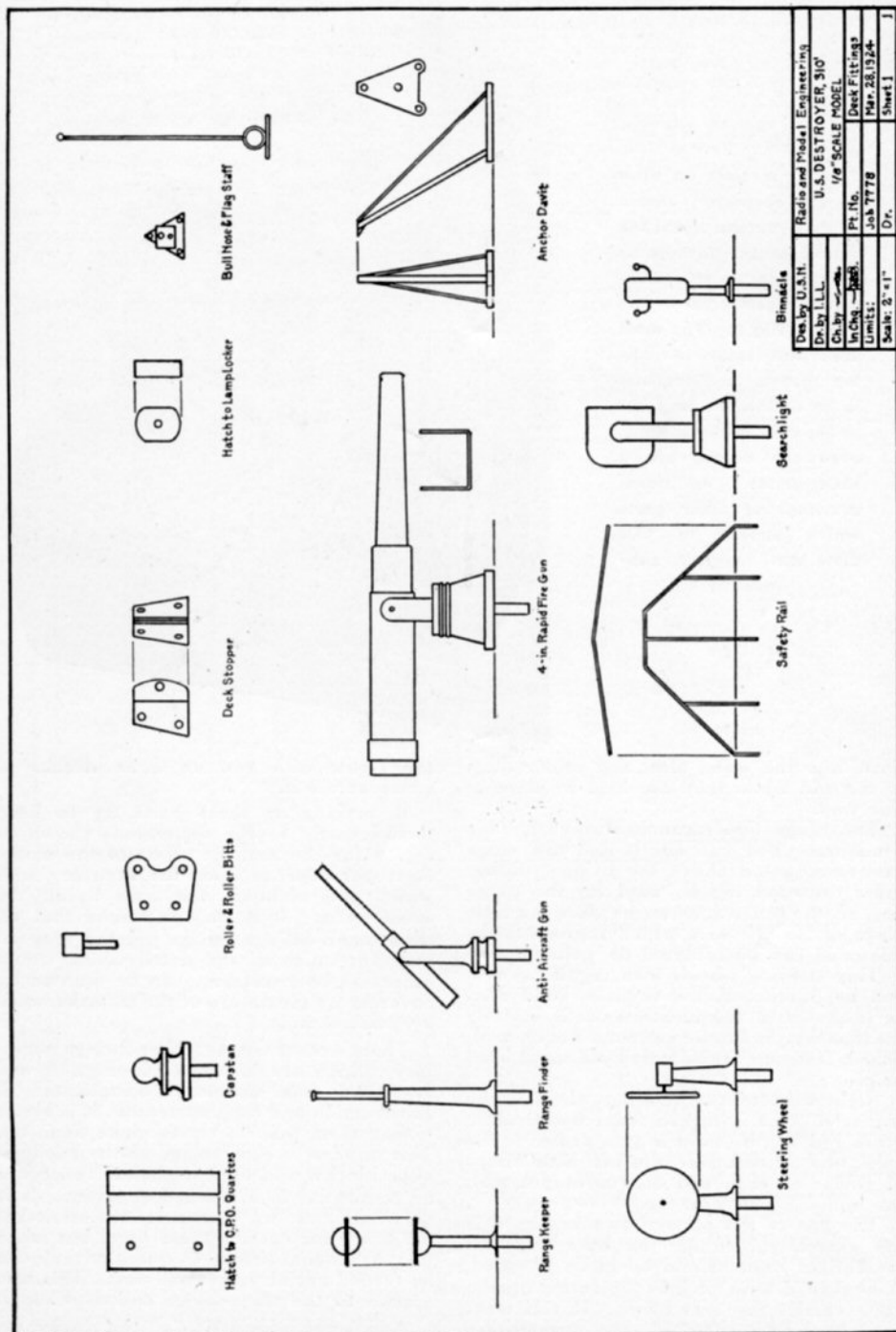

Drawn by U.S.N.	Radio and Photo Engineering
Drawn by I.L.L.	U.S. DESTROYER, 310'
Checked by	1/8" SCALE MODEL
Designed in Ctg.	Deck Fittings
Limit: 1	Job 7778
Scale: 2" = 1"	Mar. 28, 1924
	Sheet 1

Fig. 6. Drawings of the fittings shown at their actual size.

Fig. 5. A close-up view of the destroyer, shown so that you can check the details of the fittings as they appear in this illustration against the drawings in Fig. 6. The most important feature in making models look realistic is to maintain the scale in the overall dimensions, even the details are a little crude. Additional drawings of other parts which appear in this view will be given subsequently

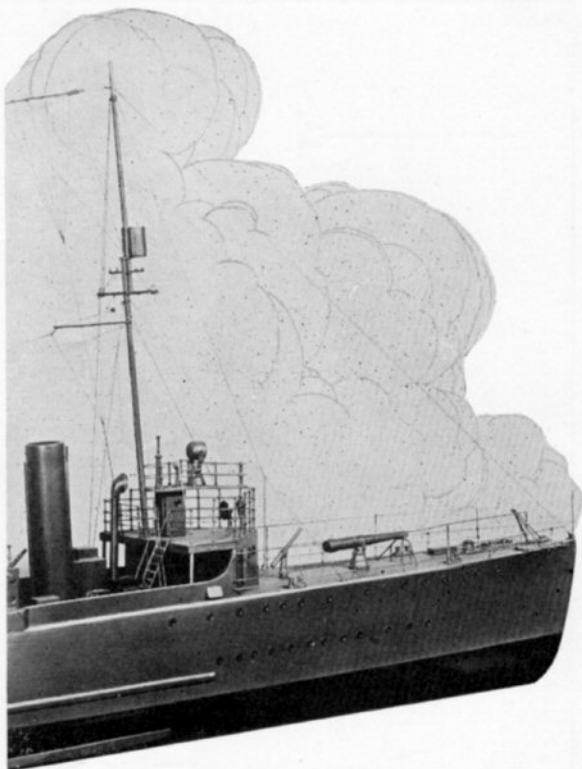

ports into the wood also, and solder them to the rail while they are held in place in this way.

The range finder can be turned from a brass rod. You can see it and the range keeper mounted above the bridge. Either brass or wood can be used for the range keeper, the brass is better because the little piece of No. 20 wire which represents the telescope can be soldered on permanently.

Tiny steering wheels with regular spokes can be purchased, but a plain, solid disc, as is shown in the illustrations, is entirely satisfactory. It can be cut from heavy cardboard, fastened to the port by a small brad or pin.

Right next to the steering wheel is the binnacle. This is turned from wood, altho brass rod can be used if you prefer. The balls, one on each side, are just little lumps of solder at each end of a wire put thru the binnacle and bent up.

The last of the parts shown in Fig. 6 is the searchlight. Both the base and the searchlight itself should be made of wood. A U shaped strip of brass, pivotted on the base, carries the searchlight. If you want to go to a little extra trouble, a small disc of glass can be fitted into a recess on the searchlight, or you can paint it black on

the front, with two or three streaks of white across it.

In making up these parts try to keep them exactly to the dimensions shown in Fig. 6 for the realistic effect of the model destroyer depends upon the accuracy with which you maintain the scale in all the small parts. It is very fortunate that all these small fittings can be painted gray all over for much of the detail which would otherwise be necessary, can be omitted by covering up the nature of the materials used by paint.

There are, of course, other fittings necessary, which are illustrated in Figs. 4 and 5. These are somewhat complicated in construction and for that reason, it is better to buy them than to try to make them up. This applies to such things as the anchors, bits, blocks, and anchor chain. Those can be purchased in a finished condition. It is very difficult to construct the patterns necessary for casting these parts but when they are manufactured in quantity they can be turned out at very small cost. This also applies to the staunchions and ventilators.

Additional information on the rigging on the forward part of the destroyer will be given subsequently.

Super HETERODYNE

The first and only book giving full construction data for the Super-heterodyne using the new Acme 30 K. C. intermediate transformers.

Price 50c.

Your dealer can supply you, or get it for you if you ask him, from

M. B. SLEEPER, Inc.
Technical Publisher
A-52 Vanderbilt Ave., New York

SHERMATRAN

TYPE AV 2-15 VARIABLE

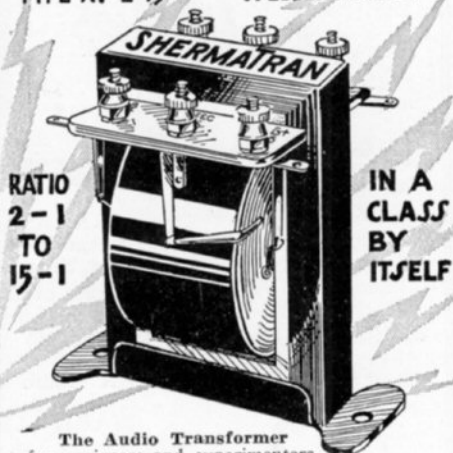

RATIO
2-1
TO
15-1

IN A
CLASS
BY
ITSELF

The Audio Transformer for engineers and experimenters on special circuits. Buy from dealer, or sent postpaid on receipt of price.....\$7.00
Standard Types
Ratios, 3½:1, 4:1, 5:1, 6:1. List.....\$6.00
Send for Booklet

Sherman Radio Distributing Co.,
112 & 114 TRINITY PLACE, N. Y. C.

NEW "HOOK-UPS" MADE EASY WITH "GNOME BRAND" RADIO KITS

KIT NO. 1
CONTAINS
22 TOOLS
INCLUDING
GOOD ELECTRIC
SOLDERING IRON
AUTOMATIC
CENTRE PUNCH,
COMBINATION
SQUARE,
SCRIBER,
PANEL CLAMP,
ETC., ETC.

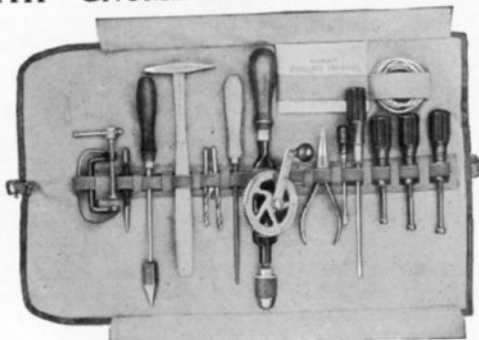

KIT NO. 3
CONTAINS
16 OF THE
MOST ESSENTIAL
TOOLS,
INCLUDING THE
FAMOUS
SPINTITE
NUT WRENCHES,
SOLDER, DRILLS,
ETC., ETC.

ILLUSTRATION SHOWS KIT NO. 3

These Tool Kits are designed especially for radio construction work and should instantly appeal to the man who likes to experiment with new "hookups." The tools are all guaranteed and of the finest quality and practical in every respect.
We carry a complete stock of "B" Batteries, "C" Batteries, Voltmeters, Ammeters, etc., etc. Prices upon application. Ask for Catalog No. 279.

HAMMACHER, SCHLEMMER & CO., Inc.
HARDWARE, TOOLS AND FACTORY SUPPLIES
NEW YORK, SINCE 1848 4TH AVE. AND 13TH STREET



a better transformer!

ARK Audio Frequency Transformers mark an epoch in audio transformer design. They are better because their design is better!

Think of an audio frequency transformer so moisture proof that it can be placed under water without damage; so perfect that three steps can be used without distortion! Yet those are only a few of the ARK Audio Transformer's features.

\$5
LIST

MAKE ARK A PART OF YOUR SET!

DISTRIBUTED BY
CLARK & TILSON
1 East 42 St., New York City

PUDLIN GRID LEAKS

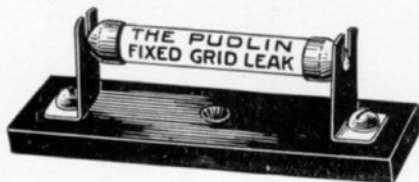

A grid leak is placed in the circuit for the purpose of dissipating an unnecessary EMF which is induced on the grid of the tube. To do this efficiently, a leak must meet certain requirements. The correct resistance feature is easily obtained and is probably accurate in all grid leaks. The constancy of this rated resistance, however, is the all-important factor. Pudlin fixed grid leaks never vary from the marked resistance under any conditions of atmosphere or operation.

Operation is absolutely noiseless and there is no internal capacity to offset or neutralize the effect of the grid condenser. This is the reason why leading manufacturers of sets and discriminating dealers always specify Pudlin Grid Leaks.

If your dealer hasn't them, write us.

PUDLIN ENGINEERING CO., INC.

110 W. 40th STREET

NEW YORK CITY

Supremacy Proven
by Every Test!

The filament control **KO-STAT** of infinite adjustment

The SCIENTIFICALLY CORRECT
RADIO RHEOSTAT
for All Tubes !!

Can You "TUNE IN"
With Your Rheostat

DX stations you never heard before and silent tube operation is yours with a Filkostat in any hook-up, using any type of tube.

It makes your tube an important tuning unit—for FIL-KO-STAT is more than a rheostat. Its critical control, spread over four turns of the knob, enables you to "tune in" DX stations that no other control on your set will get. Tube reradiation is eliminated through micrometer vernier adjustment of filament heat (electronic flow).

Radio Stores Corporation

Sole International Distributors
HOME OFFICE, Dept. RE3

220 West 34th Street
New York

(Branches
in Leading
Cities)



Price
\$2 AT YOUR DEALER
IN CANADA 275

MADE BY
DX INSTRUMENT CO.
HARRISBURG, PA.

Unconditionally Guaranteed

For Transmission
or Reception!

"FRESHMAN SELECTIVE"

Variable Condenser

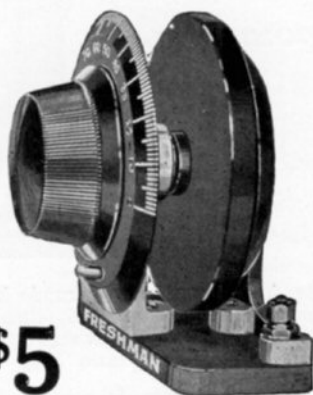

\$5

It has been conceded by the Foremost Radio Engineers that a Variable Condenser with Mercury plates is the most efficient for fine adjustment and selective tuning. Our engineers, after exhaustive experiments and research work, have developed a Variable Condenser with Mercury plates separated by heavy Mica dielectric. It is the ONLY VARIABLE CONDENSER the plates of which actually vary in area—AN ENGINEERING FEAT NEVER ACCOMPLISHED BEFORE.

No Leakage
Absolutely quiet
No plate vibration
Will stand 5000 volts
Compact and attractive
Plates cannot collect dirt
Cannot become short circuited

0003 m. f. (equivalent to 17 plate) \$5 Each
0005 m. f. (equivalent to 23 plate)
001 m. f. (equivalent to 43 plate)

Complete with three-inch Vernier dial

At your dealer, otherwise send purchase price and you will be supplied postpaid

Ask your dealer or write direct for free diagrams of Neutrodyne, Tri-Flex Polydyne and Super-Heterodyne Circuits.

Chas. Freshman Co. Inc.
Radio Condenser Products

106 SEVENTH AVE.

NEW YORK

STANDARD of EXCELLENCE

for audio

amplification

Announcing

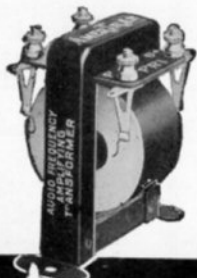

Type AF-7 (Turn ratio $3\frac{1}{2}$)

Improve your set
with an
AmerTran



Send for
Circular

The AmerTran is now made in two types: AmerTran AF-6 (turn ratio 5) is for use in the first stage; AmerTran AF-7 (turn ratio $3\frac{1}{2}$) is the

companion transformer for use in further stages of amplification. Ask your Electrical Dealer; or sent carriage charges collect. Price, each type, \$7.

American Transformer Co., 173 Emmet St., Newark, N. J.
Designers and builders of radio transformers for over 22 years

Mail The Coupon

And you will
receive
**ABSOLUTELY
FREE**
This Big 38 Page
Book

Free!



This book will tell you how to build the amazing new **HARKNESS RECEIVER**—the one-tube set which operates a loud-speaker

The Radio Guild, Inc.
256 West 34th St., New York City.

Without obligation of any kind mail me postpaid a copy of your booklet "HOW TO BUILD THE HARKNESS RECEIVER."

Name

Full Address

This may be the trouble
with YOUR set—

You can probably change
your grid leak for higher
Detecting Efficiency

The highest efficiency can only be
obtained by changing both resistor
and condenser

Can You Do This?



THE DAVEN COMBINED RESISTOR-
CONDENSER MOUNTING DOES BOTH

If your dealer cannot supply you
write

Daven Radio Company

Resistor Specialists

9-15 Campbell Street - Newark, N. J.

DX RECEIVER: The set that always makes good under all conditions, bringing distant stations with loud speaker volume and crystal clarity. Particularly suited for those not experienced in radio. Price of complete set of parts, exclusive of batteries and tubes, with instruction book and six full-size blue prints, **\$60.00.**

X-4000: A two-control regenerative set, using one UV199 tube, which brings in near-by stations on a loud speaker and almost everything with the telephones. Price of complete set of parts, exclusive of batteries and tubes, with instruction book and three full-size blue prints, **\$26.00.**

SUPER-HETERODYNE: The only design for a super-heterodyne using seven UV-199 tubes. Both electrically and mechanically it is the finest of the super sets. Price of complete set of parts including loop, instruction book and six full-size blue prints, but without tubes or batteries, **\$82.00.**

PORTABLE TUNED R. F.: The type 5800 receiver, described in this issue of R and M, is an ideal outfit for the motor boat, summer camp, automobile tour, or hike. Price of complete parts, exclusively of tubes and batteries, with three full-size blue prints, **\$40.00.**

The Finest Sets You Can Build

Listed above are four sets which have been 100% successful in the hands of radio Experimenters and novices as well. They are recommended without reservation in their particular classes, so favorable have been the reports from those who have used them.

DURRANT can also furnish all parts and supplies required to build any set described in R. & M. Note: Orders for C. O. D. shipments must be accompanied by a remittance of one-fourth the amount of the order.

DURRANT RADIO, Ltd.

AS NEAR AS YOUR MAIL BOX
A—52 Vanderbilt Avenue New York City

Standardized Parts List

The materials used to make up the set described in this issue were supplied by the following companies. The manufacturers whose names appear below will be glad to send you bulletins describing other products which they make. Please mention R & M when you write them.

PARTS FOR THE TYPE 5800 PORTABLE R. F. RECEIVER

Type	Name	Price
	Amsco Products, Inc. Broome & Lafayette Sts., New York	
1017	2—50-ohms rheostat	\$2.30
	Carter Radio Co. G-209 So. State St., Chicago, Ill.	
101	1—1-spring jacks	\$.70
103	1—3-spring filament control jack	.90
	Clark & Tilson, Inc., A-1 E. 42d St., New York City.	
	2—Audio frequency transformers	10.00
	Cornish Wire Co., R-30 Church St., New York City.	
	1—1/4-lb. spool No. 24 S. C. wire	.50
	1—1/4-lb. spool No. 20 D. C. C. wire	.40
	Dubilier Condenser & Radio Corp., A-48 W. 4th St., New York City.	
601	1—0.00025 mfd. Micadon	.35
	Electrad, Inc., 428-X Broadway, New York City.	
RM	1—Variomh Gridleak	.75
	General Instrument Co., Broome Street, New York City.	
310	2—0.0005 mfd. variable condensers	5.50
	General Radio Co., 11-R Windsor St., Cambridge, Mass.	
299	4—UV199 sockets	3.00
	H. H. Eby Mfg. Co., X-40 S. 7th St., Philadelphia, Pa.	
Ensign	9—Ensign binding posts	1.80
	James Goldmark Co., B-83 Warren St., New York City.	
W	1—1/2-lb. spool of Wlrit	.90
	Kurz-Kasch Co., South Broadway, Dayton, Ohio.	
A-213	2—3-in. tapered knobs and dials	\$1.50
A-212	2—2-in. tapered knobs and dials	1.20
	Mitchell-Rand Mfg. Co., 18-F Vesey Street, New York City.	
7	6—Lengths special varnished tubing	.90
	Poster & Co., 26-C Barcla St., New York City.	
154	1—7x14x3 16-in. Formica panel	2.49
98	2—3 x 22 1/2 x 3/16-in. Formica panels	5.52

Miscellaneous Parts

58	2—pkgs. 25 tinned soldering lugs	.50
22	1—Right hand nickeled angle bracket	.10
185	1—Left hand nickeled angle bracket	.10
63	2—pkgs. 10 1/2-in. 6-32 R. H. nickeled screws	.24
143	2—pkgs. 10 1-in. 6-32 R. H. nickeled screws	.28
49	2—pkgs. 10 6-32 nickeled nuts	.16
151	4—Terminal panel supports	1.20
	1—Aluminum shield	.40
14	4—Coil support pillars	.32

COMPLETE SETS OF PARTS \$39.71

Auxiliary Parts

	Eastern Radio Mfg. Co. 22-L Warren St., New York.	
KT1	Pickle bottle fikit, complete	\$2.00
	National Carbon Company Long Island City, N. Y.	
763	Small 22 1/2-volt B battery	\$1.75
766	Large 22 1/2-volt B battery	3.00
767	Large 45-volt B battery	5.50
771	4 1/2-polt variable battery	.70
6810	50-amp. storage battery 6-volts	15.00
	Stanley Patterson West & Hubert Sts., New York City	
843	Deveau Gold Seal Phones, 2200 ohms	6.00
844	Deveau Gold Seal Phones, 3200 ohms	8.00
	Music Master Corp. A-Cherry St., Philadelphia, Pa.	
14	Music Master Loud Speaker 14-in. horn	30.00
21	Music Master Loud Speaker, 21-in. horn	35.00
	Clark and Tilson, Inc. 1-A East 42nd St., New York City	
W	Automatic drilling template	1.00
	C. Brandes, Inc., 273-M Lafayette St., New York City	
	Brandes Table Talker	10.00
	Pacent Electric Co. A-22 Park Pl., New York City	
40	Universal phone plug	.50
51	Twinadapter for two plugs	1.00
	Stevens & Company 395 Broadway, New York City	
	Set of 3 Spintite wrenches for nuts	1.00
	BLUE PRINTS 5800 Set of 3 full-size blue prints of type 5800 receiver	.75

SPECIAL COMBINATION OFFER

You can get the set of three full-size blueprints for the type 5800 tuned R. F. receiver without charge if you take advantage of this special combination offer. Fill out this coupon and mail it at once.

M. B. Sleeper, Inc., New York.

Enter my subscription to Radio and Model Engineering for one year, for which I enclose \$2.00, and send me free the full-size prints of the 5800 receiver.

Name

Street

City State

COMPARE

The Patented Method of Mounting CARTER "HOLD-TITE" JACKS

with all others. Note what a great stride has been made in simplifying radio set building. *No spacer washers* are used with Carter Jacks to confuse and cause trouble. Look them all over and then you see why the big majority buy Carter Jacks. Made in ten styles. Fit all circuits.

Any dealer can supply you.

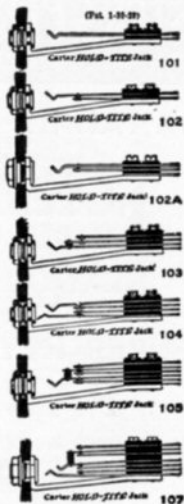

Write for
Catalog.

SHERMAN KANT SHORT BRASS PLATE VERNIER CONDENSER

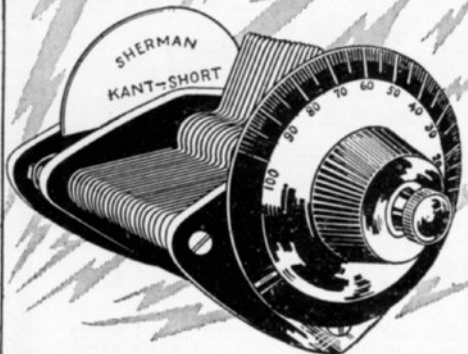

STANDARD OF PERFECTION

A splendid experimental and efficiency instrument. Buy from dealer, or sent post paid on receipt of price.

26 Plate (vernier).....\$5.50
46 Plate (vernier).....\$6.50

Send for Booklet

Sherman Radio Distributing Co.,
112 & 114 TRINITY PLACE, N. Y. C.

514-Page RADIO Handbook Only \$1

Just off the press. The greatest book on Radio ever written. 514 pages. Compiled by Harry F. Dart, B.S.E.E., formerly with the Western Electric Co., and U. S. Army Instructor of Radio. Technically edited by F. H. Doane. Filled with sound, practical, tested information for every radio fan, from beginner to hard-boiled owl. Send \$1 to-day, and get this 514-page I. C. S. Radio Handbook before you spend another cent on parts. Money back if not satisfied.

Mail the Coupon To-day

INTERNATIONAL CORRESPONDENCE SCHOOLS
Box 8777, Scranton, Penna.

I enclose One Dollar. Please send me—postpaid—the 514-page I. C. S. Radio Handbook. It is understood that if I am not entirely satisfied I may return this book within five days and you will refund my money.

Name.....

Address.....

POSTER'S PERFECT PANELS

THE RECOGNIZED STANDARD

ENGRAVING-MACHINING

FORMICA
BAKELITE
RADIO PANELS

HEADQUARTERS
FOR
SUPER-HETERODYNE
PANELS

ENGRAVED, DRILLED & POLISHED
ALSO
BINDING POST MOUNTS

BUY THROUGH YOUR
DEALER OR JOBBER

POSTER & CO. INC.

26-28 BARCLAY ST. N.Y. TEL. CORT. 4965-6
(WHOLESALE ONLY)

ENGINEERS

know why

EBY

Quality

BINDING POSTS

ARE NOW AMERICA'S STANDARD

*Inspect them yourself
and find out why*

The H. H. Eby Mfg. Co.
Phila., Pa.

Just three taps

*and you're
ready to drill
accurately!*

\$ **1**
LIST

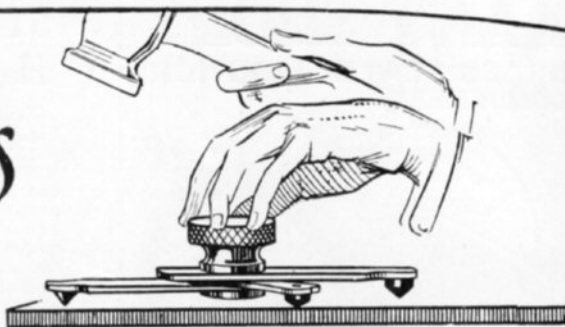

The Church AUTOMATIC TEMPLATE

WHY run the risk of spoiling your panel when the Church AUTOMATIC TEMPLATE makes it so easy to drill holes exactly where they should be drilled. No rulers, no scribers, no dividers—just three taps and the work is done!

You **NEED** the Church AUTOMATIC TEMPLATE. Get one today!

SOLE DISTRIBUTORS

CLARK & TILSON Inc.
1 East 42 Street N.Y.C.

MODEL SHIP FITTINGS

**Boucher Ship Fittings Are Accurately Made to
1/8 inch or 1/4 inch Scale**

In the BOUCHER catalog you will find all kinds of parts, materials, tools, wood blocks, paints, and equipment listed which every model maker requires. Of special interest is the section devoted to parts for scale exhibition models. There are all kinds of tiny blocks, cleats, running lights, ventilators, propellers, bits, chocks, life rings, davits, stanchions, air ports, searchlights, winches, and fittings all exactly to scale. Every tiny detail of the parts is worked out perfectly, with the same care that is used in fittings for models supplied to steamship companies and the U. S. and foreign navies. A copy of this unabridged catalog number 502 will be sent you upon receipt of 25c in stamps.



BOUCHER, Inc.

SCALE MODELS

415 Madison Avenue

New York City

RECEPTRAD

V. GREIFF'S

Manual on

SUPER-HETERODYNE

Now ready \$1.50 Post paid

SUPER-HETERODYNE PARTS ARE BEST

because they are built and tested together

OSCILLATORS — FILTER COUPLERS
R.F. 1716 TRANSFORMERS—1 MFD CONDENSERS

PRODUCTS OF RADIO RECEPTOR CO.

Nationally distributed by

New Amsterdam Electric Co.

16 Hudson Street

New York, N. Y.

And Now
for **ROUND** nuts
Spintite

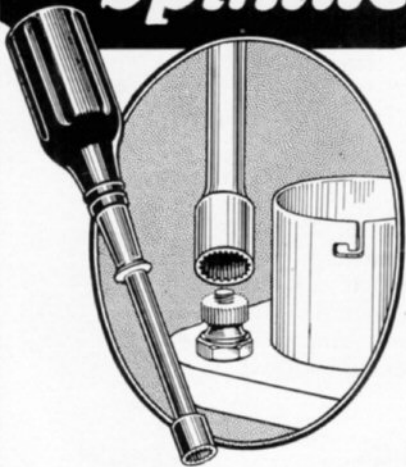

Thousands of radio fans who have been enthusiastic users of Spintite Hex Nut Wrenches have been waiting eagerly for the "ROUND NUT" type. The sharp milling on the inside of the "Round Nut" Spintite holds the nut in a can't-slip grip. With these handy Spintites, ALL your connections will be AS TIGHT AS IF SOLDERED.

Set of 3 Spintites for round nuts, \$1.00
Set of 3 Spintites for hex nuts, 1.00
Set of 7 Spintites for all hex nuts, 3.50

Special Tools for Radio Fans

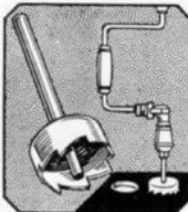

Stevens Panel Cutters for making clean cut holes. Sizes, $\frac{3}{8}$ " , \$.75; 1" , \$.85; $1\frac{1}{2}$ " , \$1.00.



Stevens Speed-a-loop Pliers for quickly bending perfect loop terminals, \$1.50.

At your dealer's, or if he can't supply you, send his name and order direct from us

Write for Radio Tools Booklet
STEVENS & COMPANY
Toolsmiths since 1899

375 Broadway New York

Stevens *SPEED-UP* **Tools**

Wave Length Limitations

Are now conquered. It does not matter whether you receive at 50 meters or 50,000 meters. All you need is proper inductance — and that means

The Low Loss

General Instrument Corporation

Grounded Rotor Condenser

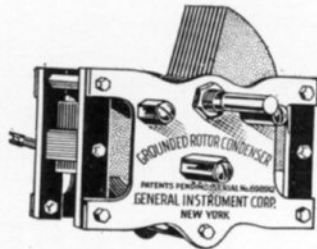

37% More Distance and Volume

Than Is Possible with the Average Variable Condenser

CHARLES SREBROFF, operator and owner of station 2BHY writes, "You can use my name in your advertisements so that other amateurs may profit by my experience with your Low Loss Grounded Rotor Condenser. There is no other condenser to equal yours and I can honestly say that my station is entirely free from any condenser losses since using your GROUNDED ROTOR CONDENSER. Amateurs can call me any night between 11 p. m. and 1 a. m. on 180 metres—three operators always on watch."

	Minimum	Maximum	
Type 46X...11 Plate	5 mmfd	.00025 mfd	\$4.50
Type 46A...13 Plate	6 mmfd	.0003 mfd	4.50
Type 46D...21 Plate	9 mmfd	.0005 mfd	5.00
Type 46F...43 Plate	15 mmfd	.001 mfd	5.50

AT YOUR DEALER

Otherwise Send Purchase Price Direct to Us
And You Will Be Supplied

GENERAL INSTRUMENT CORPORATION

423 Broome Street, New York City

Read This

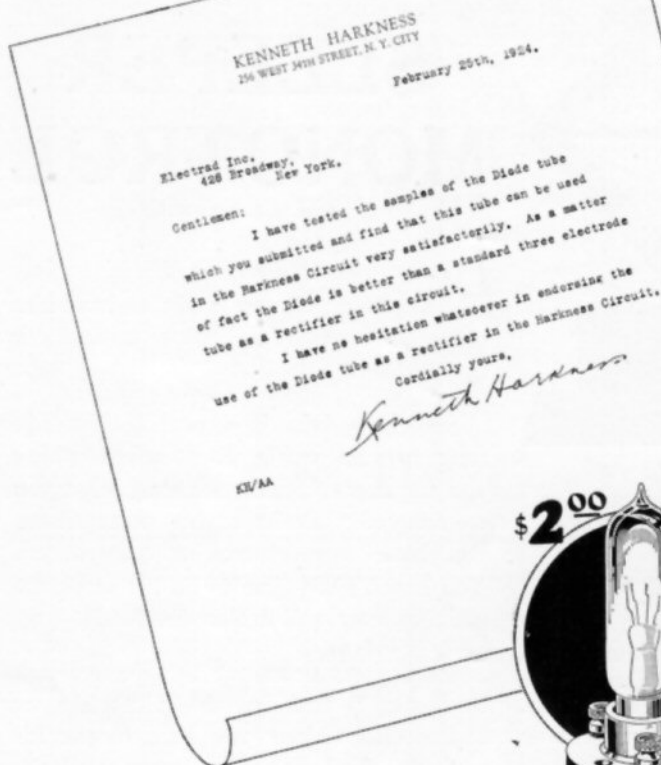

KENNETH HARKNESS
256 WEST 34th STREET, N. Y. CITY

February 26th, 1924.

Electrad Inc.
426 Broadway,
New York.

Gentlemen:

I have tested the samples of the Diode tube which you submitted and find that this tube can be used in the Harkness Circuit very satisfactorily. As a matter of fact the Diode is better than a standard three electrode tube as a rectifier in this circuit.

I have no hesitation whatsoever in endorsing the use of the Diode tube as a rectifier in the Harkness Circuit.

Cordially yours,

Kenneth Harkness

KH/AA

\$2.00

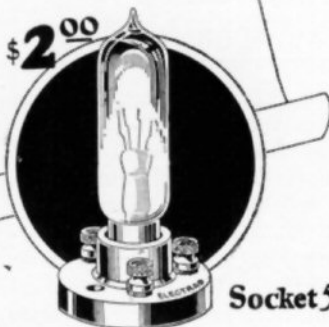

Socket 50¢

The New Diode Tube *for the marvelous* Harkness Reflex Circuit

Diode Tubes give you greater volume, never get out of adjustment, stabilize the circuit, and are far more sensitive than even the better grade crystals. They require no B Batteries, and will burn from 600 to 1000 hours on $1\frac{1}{2}$ volt battery. FREE! Ask your dealer for our complete and detailed diagram of the Harkness Reflex Circuit and instructions for use of the Diode Tube in place of a crystal.

Electrad, Inc., New York City

ELECTRAD

A Name Stamped Only on Superior Radio Products



Model 52

Four-Tube Monotrol

The only set using the same tubes for both radio and audio amplification in which the load on each tube is balanced, thus permitting each tube to operate at full efficiency without distortion. By using the tapped-loop volume control, the critical potentiometer adjustment is done away with, leaving only one control for tuning. This dial can be calibrated for all stations, and does not change wherever the set is used.

Write for a descriptive booklet on the Sleeper Monotrol.

Tell him to get a **SLEEPER MONOTROL**

Reg. U. S. Pat. Off.

DID you ever advise a friend to buy a certain radio set, and then have him call you over twice a week or so to fix it up for him?

Somehow friends expect you to do their service work when, after asking you for expert advice, they buy what you recommend. Perhaps, for that reason, you have stopped making suggestions. You haven't the time to do the work the manufacturer and dealer should do.

But it isn't necessary to side-step that way. Say to your friend—"Get a Sleeper Monotrol." Then you can forget his troubles—he won't have any. He'll be grateful to you each time he tunes in on the Monotrol.

Single tuning dial, highly selective and the pure crystal-clear tonal quality that only a loop with a set built for loop reception can give.

"The Most Perfect Radio Set in America"

SLEEPER RADIO CORPORATION

F-88 Park Place

New York City

What David Grimes says about Acme Radio Frequency Transformers

Read this sincere appreciation of the reliability of Acme apparatus

DAVID GRIMES
No. 1 Windemere Road, Durkee Manor,
Staten Island, N. Y.

October, 26, 1923

ACME APPARATUS COMPANY,
Cambridge, Mass.

Dear Sirs:—You have often heard that a chain is no stronger than its weakest link. The successful operation of my Inverse Duplex System depends absolutely on an efficient radio frequency circuit being used in connection therewith.

It will probably interest you to know that I have been using your radio frequency transformers almost from the start and that I have always insisted upon them being employed in my demonstration sets. I have recommended them in many of my articles and most of my lectures. Judging from my own experience and those of my numerous correspondents, I can now safely tell you that you have "done a fine job."

It gives me special pleasure to write this letter because you have never solicited it. Yours truly,
(Signed David Grimes)

Amplification without distortion

The Acme Apparatus Company have succeeded in building transformers which give results, such as Mr. Grimes testifies to, because they have specialized in the study of amplification. The popular A-2 Audio Amplifying Transformer and the R-2, R-3 and R-4 Radio Frequency Transformers are known by radio users as giving the maximum amplification without distortion. If you want to get the best results from your set, send for "Amplification without Distortion"—an instructive and helpful book which explains how to get the best results with Acme Transformers in your set. It also contains a number of wiring diagrams, which are of great help in building a set.

ACME APPARATUS COMPANY
Cambridge, Mass.



The Acme R-2 Transformer (shown) and Acme A-2 Frequency Amplifying Transformer sell for \$5 each at radio and electrical stores.

ACME

~ for amplification

ACME APPARATUS COMPANY,
Dept. R.M.3 Cambridge, Mass., U. S. A.
Gentlemen: I am enclosing 10 cents (U. S. stamps or coin) for a copy of your book, "Amplification without Distortion."

Name

Street

City..... State.....

"The Best That Money Can Buy"



"DEVEAU GOLD SEAL" HEAD SETS are electrically and mechanically,—as well as from a radio standpoint,—as perfect as the highest-priced Head Set on the market,—yet, with all their perfection, they retail at only \$8.00 for 2200 Ohm and \$10.50 for 3200 Ohm.

The trade mark "DEVEAU" has stood for the highest quality in telephone apparatus for thirty years,—a guarantee that every known advantage in design and manufacturing has been taken into careful consideration.

Magnets are extra-heavy one-piece units; cups are of aluminum to keep down the weight but unlike other Head Sets, every exposed metal part of the set is finished in genuine 24-karat gold,—under a protective lacquer so that the finish will last for years; the terminals of each unit are concealed,—no contact possible with users' hands.

"DEVEAU GOLD SEAL" HEAD SETS are like a piece of fine jewelry in appearance, but with all the radio niceties that the most advanced radio enthusiast can desire. DEVEAU Units exactly match each other in tone,—each has maximum sensitivity and perfection of tone quality.

The patented design of headgear is far ahead of any Head Set on the market,—affording as it does, instant fitting to ears and head without "re-harnessing" and without binding or pressure,—the latter an admitted nuisance with all other makes of Head Sets.

Cups are of genuine Bakelite,—of scientific design, and comfortable to the ear; the bakelite never loses its jet-black lustre or highly polished surface.

"DEVEAU GOLD SEAL" HEAD SETS are never found in the cut-rate market,—they are only sold to Jobbers who appreciate their value.

"DEVEAU GOLD SEAL" HEAD SETS are guaranteed to be electrically and mechanically perfect,—our Guarantee protects every purchaser.

Order through your regular Jobber or write direct for the names of authorized Distributors throughout the country.

Send for descriptive Bulletin of Deveau Radio Apparatus and Micrometer Adjustable Air-Gap Radio Loud-Speakers.

STANLEY & PATTERSON

250 WEST STREET

Downtown Stores { 27 WARREN ST.
23 MURRAY ST.

NEW YORK, U. S. A.